

D03 Tapping Plates

P and T Port Tapping Plate

Tapping Plate hardware / interface seal kit is supplied. See page 164 for itemized list.

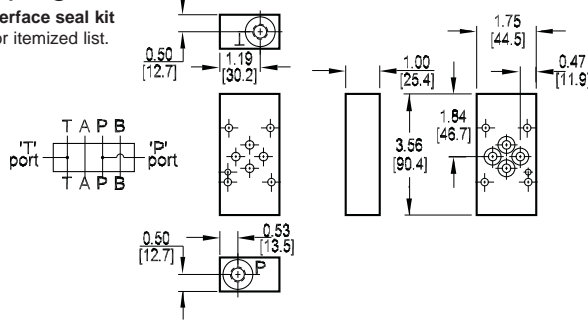

A and B Port Tapping Plate

Tapping Plate hardware / interface seal kit is supplied. See page 164 for itemized list.

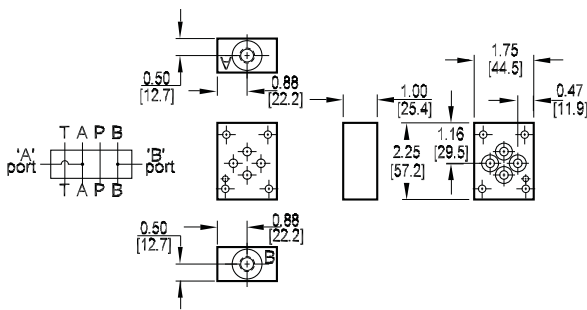

L Port Tapping Plate

Tapping Plate hardware / interface seal kit is supplied. See page 164 for itemized list.

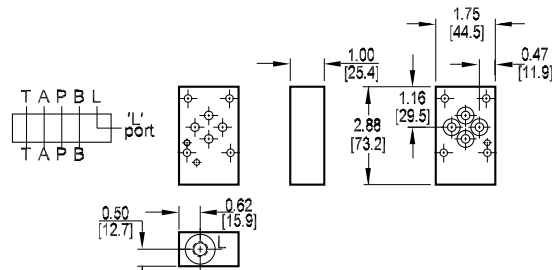

Specifications, descriptions, and dimensional data are subject to correction or change without notice or incurring obligation. Download latest catalog page revisions at www.daman.com.

Ordering Information

Material	Valve Pattern	Product Type	Circuit	Port Threads
----------	---------------	--------------	---------	--------------

Material	
A	Aluminum - 6061-T6 3000† psi • 20.7 MPa
D	Ductile Iron - D4512 5000† psi • 34.5 MPa
N	Electroless Nickel Coated Ductile Iron - D4512 5000† psi • 34.5 MPa

† Working pressure should be considered in accordance with ISO 4413 to determine appropriate material type.

Product Type	
TP	Tapping Plate

Valve Pattern	
D03	ISO 4401-03-02 NFPA T3.5.1-D03 See Tech Information

Circuit	
PT	P and T ports provided
AB	A and B ports provided
L	L port provided

Port Threads	
4P	0.25-18 NPTF ANSI B1.20.3
4S	-4 SAE ISO 11926; SAE 1926
4B	0.25-19 BSPP ISO 1179; BS 2779
4M	M10 x 1.0 ISO 6149
4T	0.25-19 BSPT ISO 7; BS 21

D03 Tapping Plates

Orifice Tapping Plate

Tapping Plate hardware / interface seal kit is supplied. See page 164 for itemized list.

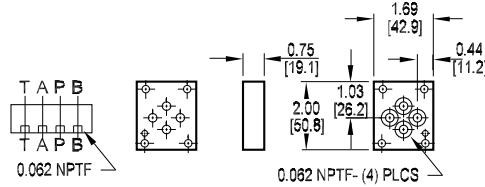

Spot Drilled Tapping Plate

Tapping Plate hardware / interface seal kit is supplied. See page 164 for itemized list.

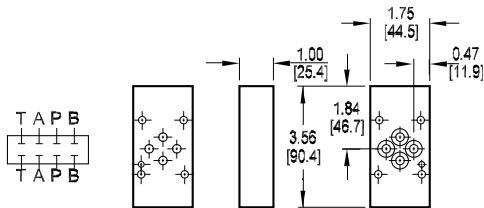

B to T vent Tapping Plate

Tapping Plate hardware / interface seal kit is supplied. See page 164 for itemized list.

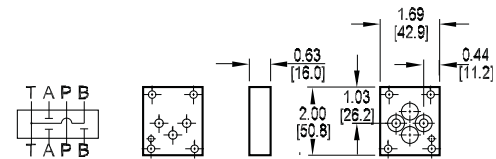

Specifications, descriptions, and dimensional data are subject to correction or change without notice or incurring obligation. Download latest catalog page revisions at www.daman.com.

Ordering Information

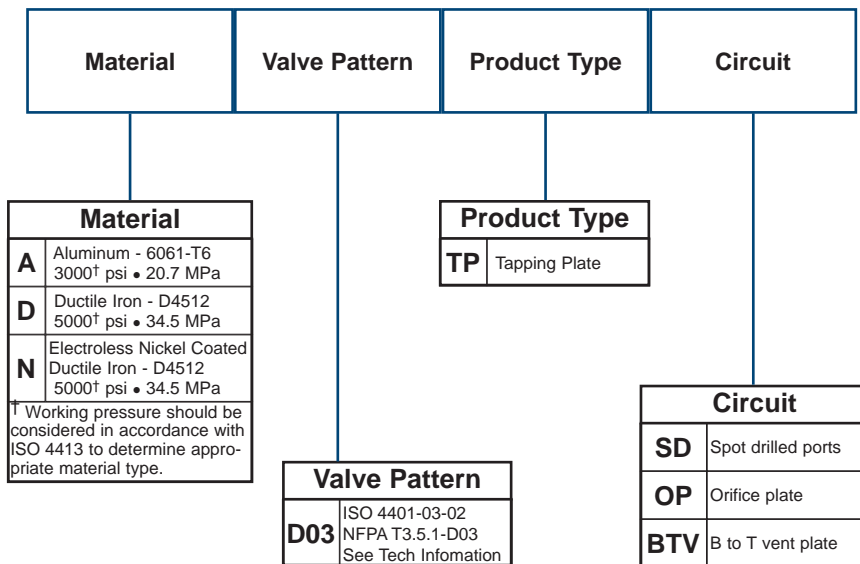

D03 Tapping Plates

D03 Two Station Tapping Plate

A₁ common to A₂, B₁ common to B₂

Tapping Plate hardware / interface seal kit is supplied. See page 164 for itemized list.

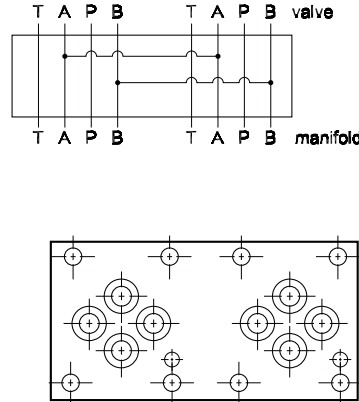
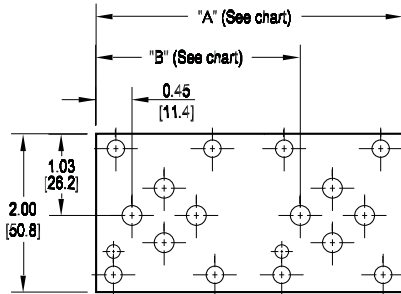

Dimension	A	B
*D03TP022AB	3.88 [98.6]	2.58 [65.5]
*D03TP024AB	5.75 [146.1]	4.45 [113.1]
L*D03TP022AB	3.75 [95.3]	2.45 [62.3]

There are two different tapping plate models with spacing code 2 available. This is necessary to cover the variation of valve spacing between the standard design and the LC (low cost) design of D03 manifolds. The standard manifold design has 2.125" valve spacing while the LC design has 2.000" valve spacing. An L is added to the front of the model number to denote the tapping plate designed to be used with the LC manifold. Note that a single model is required with spacing code 4 as both the standard and LC designs have 4.000 spacing.

Specifications, descriptions, and dimensional data are subject to correction or change without notice or incurring obligation. Download latest catalog page revisions at www.daman.com.

Ordering Information

